

21

BASSANO

Bassano è il sottolavello predisposto ad essere completato con il lavello in acciaio inox in una vasta gamma di misure.

Il mobile da 120 cm ha due ante pieghevoli: il sistema di apertura è più funzionale perché elimina l'ingombro dell'anta centrale lasciando così ampia libertà di movimento durante l'uso.

Bassano is the undersink furniture which can be completed with stainless steel sink in different sizes.

The 120 cm furniture has 2 folding doors: the opening system is more functional because it eliminates the overall dimensions of the central door giving freedom of movement.

Bassano ist ein Unterspülbeckenmöbel, das vorbereitet ist, mit Spülbecken aus Edelstahl von verschiedenen Maßen ergänzt zu werden.

Das Möbel mit 120 cm Breite hat 2 Klapptüren: Das Öffnungssystem ist praktischer, da es das Verstellen der zentralen Tür während des Gebrauchs ausschaltet.



Colori disponibili per la struttura
Available colours for the structure
Verfügbare Farben für die Struktur

bianco white Weiß 

Colori disponibili per le ante
Available colours for the doors
Verfügbare Farben für die Türen

bianco white Weiß  Afrosia Teak Teak 





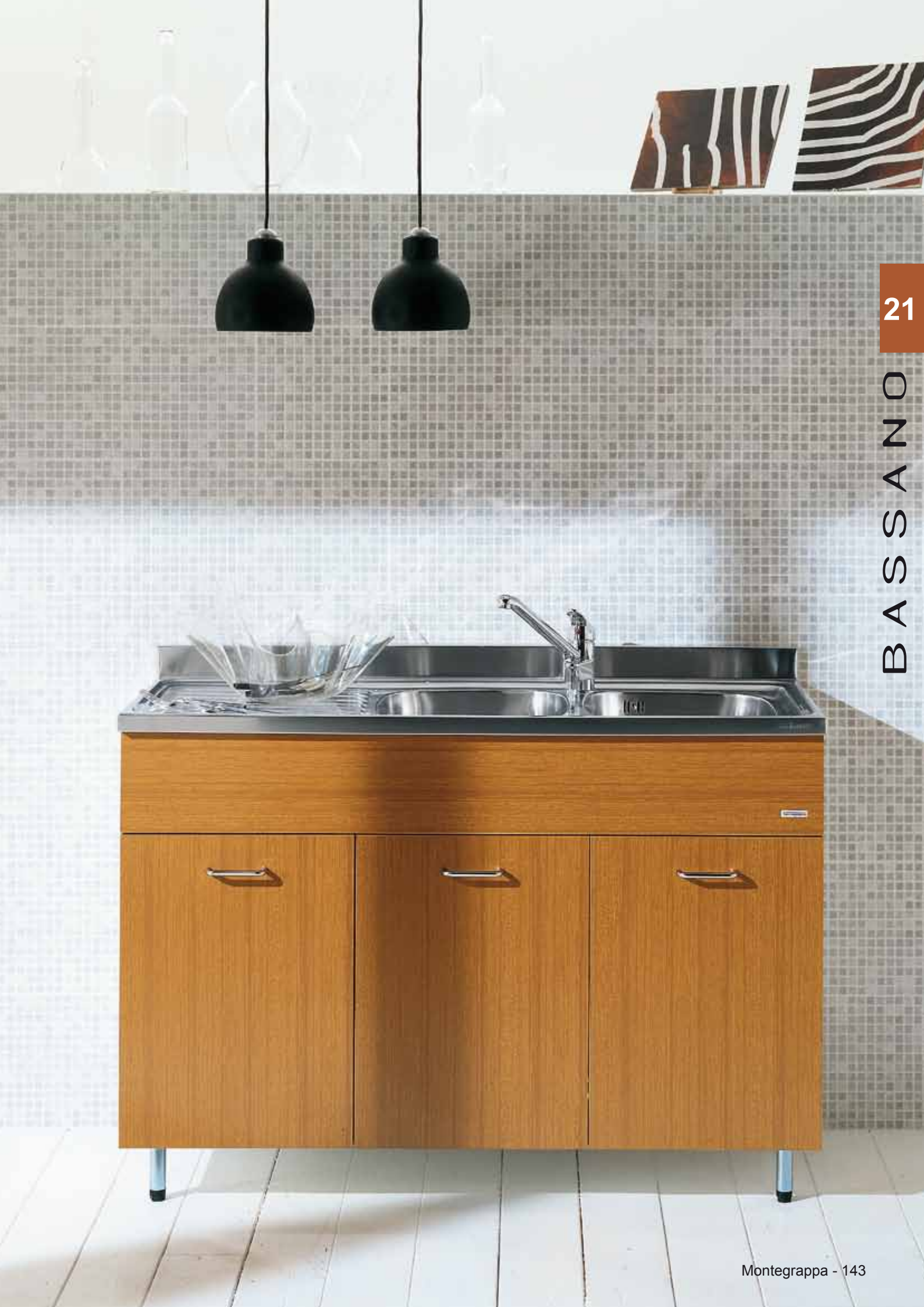

Colori disponibili per la maniglia
Available colours for the handle
Verfügbare Farben für den Griff

bianco white Weiß  marrone brown braun  cromo chromed Verchromt 













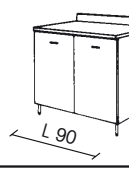

| STRUTTURA | ANTE | MANIGLIA IN NYLON |
|--|--|--|
| <p>STRUCTURE STRUKTUR</p> <p>Struttura in nobilitato bianco.</p> <p>Structure made by white faced chipboard.</p> <p>Struktur aus weißer melaminbeschichteten Spanplatte.</p> | <p>DOORS TÜREN</p> <p>Ante in nobilitato di colore bianco e afromosia.</p> <p>Door made by white or teak faced chipboard.</p> <p>Türen aus weißer, oder Teak melaminbeschichteten Spanplatte.</p> | <p>NYLON HANDLE NYLON GRIFF</p> <p>bianco white Weiß </p> <p>marrone brown Braun </p> <p>cromo chromed Verchromt </p> |
| <p>bianco white Weiß </p> | <p>bianco white Weiß </p> <p>Afrosia Teak Teak </p> | |

BASSANO MOBILI BASE H 85 Prof. 50

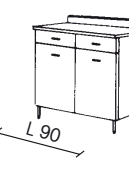
BASSANO FURNITURE H 85 D. 50

GRUNDMÖBEL BASSANO H. 85 T. 50

| ATTREZZATURE Equipping Einrichtung | CODICI Code Kode | ELEMENTI Elements Elemente | ATTREZZATURE Equipping Einrichtung | CODICI Code Kode | ELEMENTI Elements Elemente |
|--|-----------------------------------|---|--|-----------------------------------|---|
| <p>Cerniera DX Right hinges Rechte Scharniere</p> <p>Cerniera SX Left hinges Linke Scharniere</p> | <p>M.240.620</p> <p>M.240.621</p> |  <p>L 30</p> | <p>1 anta - 1 cassetto 1 door - 1 drawer 1 Tür - 1 Schublade</p> <p>Cerniera DX Right hinges Rechte Scharniere</p> <p>Cerniera SX Left hinges Linke Scharniere</p> | <p>M.240.672</p> <p>M.240.673</p> |  <p>L 60</p> |
| <p>Cerniera DX Right hinges Rechte Scharniere</p> <p>Cerniera SX Left hinges Linke Scharniere</p> | <p>M.240.624</p> <p>M.240.625</p> |  <p>L 45</p> | <p>2 ante 2 doors 2 Türen</p> | <p>M.240.630</p> |  <p>L 90</p> |
| <p>1 anta - 1 cassetto 1 door - 1 drawer 1 Tür - 1 Schublade</p> <p>Cerniera DX Right hinges Rechte Scharniere</p> <p>Cerniera SX Left hinges Linke Scharniere</p> | <p>M.240.670</p> <p>M.240.671</p> |  <p>L 45</p> | <p>2 ante - 2 cassetti 2 doors - 2 drawers 2 Türen - 2 Schubladen</p> | <p>M.240.674</p> |  <p>L 90</p> |
| <p>5 cassetti 5 drawers 5 Schubladen</p> | <p>M.240.660</p> |  <p>L 45</p> | | | |
| <p>Cerniera DX Right hinges Rechte Scharniere</p> <p>Cerniera SX Left hinges Linke Scharniere</p> | <p>M.240.626</p> <p>M.240.627</p> |  <p>L 60</p> | | | |
| <p>2 ante 2 doors 2 Türen</p> | <p>M.240.628</p> |  <p>L 60</p> | | | |

| ATTREZZATURE Equipping Einrichtung | CODICI Code Kode | ELEMENTI Elements Elemente |
|--|--|----------------------------------|
| <p>2 porte per lavello inox prof. 50</p> <p>2 doors for stainless steel sink, D. 50</p> <p>2 Türen für Spülbecken aus Edelstahl T. 50</p> <p>Largh. 80 cm W. 80 cm B. 80 cm</p> <p>Largh. 90 cm W. 90 cm B. 90 cm</p> <p>Largh. 100 cm W. 100 cm B. 100 cm</p> | <p>M.240.002</p> <p>M.240.004</p> <p>M.240.006</p> | |
| <p>2 porte per lavello ceramica prof. 45</p> <p>2 doors for ceramic sink, D. 45</p> <p>2 Türen für Spülbecken aus Keramik T. 45</p> <p>Largh. 80 cm W. 80 cm B. 80 cm</p> <p>Largh. 90 cm W. 90 cm B. 90 cm</p> <p>Largh. 100 cm W. 100 cm B. 100 cm</p> | <p>M.240.102</p> <p>M.240.104</p> <p>M.240.110</p> | |
| <p>2 porte per lavello ceramica prof. 50</p> <p>2 doors for ceramic sink, D. 50</p> <p>2 Türen für Spülbecken aus Keramik T. 50</p> <p>Largh. 90 cm W. 90 cm B. 90 cm</p> <p>Largh. 100 cm W. 100 cm B. 100 cm</p> | <p>M.240.106</p> <p>M.240.112</p> | |
| <p>3 porte ambidestro per lavello inox prof. 50</p> <p>3 doors ambidextrous for stainless steel sink, depth 50 cm</p> <p>3 Türen beidhändig für Spülbecken aus Edelstahl, Tiefe 50 cm</p> | <p>M.240.008</p> | |
| <p>3 porte ambidestro per lavello ceramica prof. 50 cm</p> <p>3 doors ambidextrous for ceramic sink, depth 50 cm</p> <p>3 Türen beidhändig für Spülbecken aus Keramik, Tiefe 50 cm</p> | <p>M.240.130</p> | |
| <p>3 porte ambidestro per lavello inox prof. 50 cm</p> <p>3 doors ambidextrous for stainless steel sink, depth 50 cm</p> <p>3 Türen beidhändig für Spülbecken aus Edelstahl, Tiefe 50 cm</p> | <p>M.240.130</p> | |
| <p>Per lavello inox - 2 porte 3 cassetti con uno attrezzato di portaposate</p> <p>For stainless steel sink, 2 doors and 3 drawers, one equipped with cutlery tray</p> <p>Für Spülbecken aus Edelstahl, Türen und 3 Schubladen, eins mit Besteckkasten ausgestattet</p> | <p>M.240.300</p> <p>M.240.301</p> | |
| <p>Cassetti a DX Drawers on the right Schubladen rechts</p> <p>Cassetti a SX Drawers on the left Schubladen links</p> | <p>M.240.300</p> <p>M.240.301</p> | |
| <p>Per lavello ceramica - 2 porte 3 cassetti con uno attrezzato di portaposate</p> <p>For ceramic sink, 2 doors and 3 drawers, one equipped with cutlery tray</p> <p>Für Spülbecken aus Keramik, Türen und 3 Schubladen, eins mit Besteckkasten ausgestattet</p> | <p>M.240.310</p> <p>M.240.311</p> | |
| <p>Cassetti a DX Drawers on the right Schubladen rechts</p> <p>Cassetti a SX Drawers on the left Schubladen links</p> | <p>M.240.310</p> <p>M.240.311</p> | |

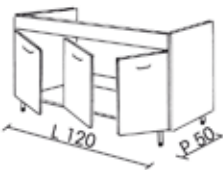
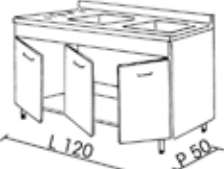
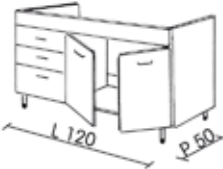
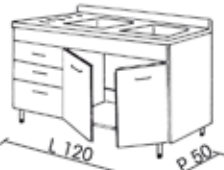

| ATTREZZATURE Equipping Einrichtung | CODICI Code Kode | ELEMENTI Elements Elemente |
|---|--|----------------------------------|
| <p>Scolapiatti a DX Draining board on the right Abtropfbrett rechts</p> <p>Scolapiatti a SX Draining board on the left Abtropfbrett links</p> <p>2 vasche 2 basins 2 Becken</p> | <p>M.240.202</p> <p>M.240.203</p> <p>M.240.204</p> | |
| <p>Scolapiatti a DX Draining board on the right Abtropfbrett rechts</p> <p>Scolapiatti a SX Draining board on the left Abtropfbrett links</p> <p>2 vasche 2 basins 2 Becken</p> | <p>M.240.206</p> <p>M.240.207</p> <p>M.240.208</p> | |
| <p>Scolapiatti a DX Draining board on the right Abtropfbrett rechts</p> <p>Scolapiatti a SX Draining board on the left Abtropfbrett links</p> <p>2 vasche 2 basins 2 Becken</p> | <p>M.240.210</p> <p>M.240.211</p> <p>M.240.212</p> | |
| <p>2 vasche 2 basins 2 Becken</p> <p>Scolapiatti a DX Draining board on the right Abtropfbrett rechts</p> <p>Scolapiatti a SX Draining board on the left Abtropfbrett links</p> | <p>M.240.214</p> <p>M.240.215</p> | |
| <p>2 vasche 2 basins 2 Becken</p> <p>Scolapiatti e cassetti a DX Draining board and drawers on the right Abtropfbrett und Schubladen rechts</p> <p>Scolapiatti e cassetti a SX Draining board and drawers on the left Abtropfbrett und Schubladen links</p> | <p>M.240.320</p> <p>M.240.321</p> | |
| <p>2 vasche 2 basins 2 Becken</p> | <p>M.240.320</p> <p>M.240.321</p> | |

| ATTREZZATURE Equipping Einrichtung | CODICI Code Kode | ELEMENTI Elements Elemente | ATTREZZATURE Equipping Einrichtung | CODICI Code Kode | ELEMENTI Elements Elemente |
|---|-----------------------------------|---|---|-----------------------------------|---|
| <p>3 porte per lavello inox con scolapiatti a</p> <p>3 doors for stainless steel sink with draining board</p> <p>3 Türen für Spülbecken aus Edelstahl mit Abtropfbrett</p> <p>DX On the right Rechts</p> <p>SX On the left Links</p> | <p>M.240.052</p> <p>M.240.053</p> |  | <p>2 vasche 2 basins 2 Becken</p> <p>Scolapiatti a DX Draining board on the right Abtropfbrett rechts</p> <p>Scolapiatti a SX Draining board on the left Abtropfbrett links</p> | <p>M.240.252</p> <p>M.240.253</p> |  |
| <p>3 porte per lavello ceramica con scolapiatti a</p> <p>3 doors for ceramic sink with draining board</p> <p>3 Türen für Spülbecken aus Keramik mit Abtropfbrett</p> <p>DX On the right Rechts</p> <p>SX On the left Links</p> | <p>M.240.152</p> <p>M.240.153</p> | | | | |
| <p>Per lavello inox - 2 porte 3 cassetti con uno attrezzato di portaposate</p> <p>For stainless steel sink, 2 doors and 3 drawers, uno equipped with cutlery tray</p> <p>Für Spülbecken aus Edelstahl, 2 Türen und 3 Schubladen, eins mit Besteckkasten ausgestattet</p> <p>Cassetti a DX Drawers on the right Schubladen rechts</p> <p>Cassetti a SX Drawers on the left Schubladen links</p> | <p>M.240.302</p> <p>M.240.303</p> |  | <p>2 vasche 2 basins 2 Becken</p> <p>Scolapiatti cassetti a DX Draining board and drawers on the right Abtropfbrett und Schubladen rechts</p> <p>Scolapiatti cassetti a SX Draining board and drawers on the left Abtropfbrett und Schubladen links</p> | <p>M.240.322</p> <p>M.240.323</p> |  |
| <p>Per lavello ceramica - 2 porte 3 cassetti con uno attrezzato di portaposate</p> <p>For ceramic sink, 2 doors and 3 drawers, uno equipped with cutlery tray</p> <p>Für Spülbecken aus Keramik, 2 Türen und 3 Schubladen, eins mit Besteckkasten ausgestattet</p> <p>Cassetti a DX Drawers on the right Schubladen rechts</p> <p>Cassetti a SX Drawers on the left Schubladen links</p> | <p>M.240.312</p> <p>M.240.313</p> | | | | |

BASSANO ARMADI SCOLAPIATTI H 71 Prof. 37

BASSANO PLATE RACK CABINETS H. 71 D. 37

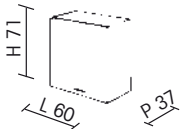
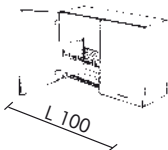
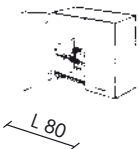
ABTROPFBRETTSCHRÄNKE BASSANO H. 71 T. 37

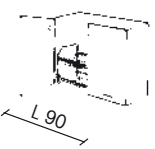
| ATTREZZATURE Equipping Einrichtung | CODICI Code Kode | ELEMENTI Elements Elemente | ATTREZZATURE Equipping Einrichtung | CODICI Code Kode | ELEMENTI Elements Elemente |
|--|------------------------|---|--|------------------------|---|
| Cerniera DX Right hinges Rechte Scharniere Cerniera SX Left hinges Linke Scharniere | M.240.702 M.240.703 |  | 2 ante 2 doors 2 Türen | M.240.710 |  |
| 2 ante 2 doors 2 Türen | M.240.706 |  | Armadio DX Cabinet right Schrank rechts Armadio SX Cabinet left Schrank links | M.240.714 M.240.715 |  |
| 2 ante 2 doors 2 Türen | M.240.708 |  | | | |

BASSANO ARMADI CAPPA H. 43 Prof. 37

BASSANO CABINETS WITH COOKING HOOD H 43 D 37

SCHRÄNKE BASSANO MIT ABZUGSHAUBE H. 43 T. 37

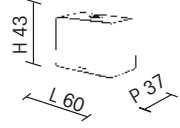
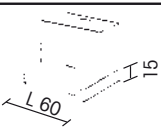
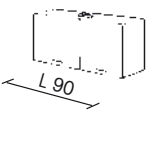
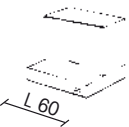
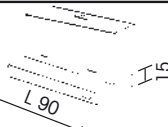
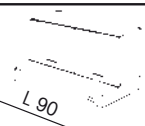
| ATTREZZATURE Equipping Einrichtung | CODICI Code Kode | ELEMENTI Elements Elemente | ATTREZZATURE Equipping Einrichtung | CODICI Code Kode | ELEMENTI Elements Elemente |
|--|------------------------|---|---|------------------------|---|
| Cerniera DX Right hinges Rechte Scharniere Cerniera SX Left hinges Linke Scharniere | M.240.820 M.240.821 |  | Aspirante Cooking hood Abzugshaube Cerniera DX Right hinges Rechte Scharniere Cerniera SX Left hinges Linke Scharniere | M.240.830 M.240.831 |  |
| 2 ante 2 doors 2 Türen | M.240.822 |  | Depurante Cooking hood with filter Abzugshaube mit Filter Cerniera DX Right hinges Rechte Scharniere Cerniera SX Left hinges Linke Scharniere | M.240.832 M.240.833 |  |
| | | | Aspirante Cooking hood Abzugshaube | M.240.834 |  |
| | | | Depurante Cooking hood with filter Abzugshaube mit Filter | M.240.835 |  |

21

BASSANO

BASSANO CUCINA CON FORNO Larg. 60 Prof. 50 H 85

BASSANO COOKING HOBS WITH OVEN W. 60 D. 50 H. 85 KOCHPLATTEN BASSANO MIT OFFEN B. 60 T. 50 H. 85

| ATTREZZATURE Equipping Einrichtung | CODICI Code Kode | ELEMENTI Elements Elemente |
|---|------------------------|---|
| In acciaio Inox steel Stahl | M.225.048.011 |  |
| 4 fuochi gas e accensione elettrica e valvole di sicurezza 4 gas burners, electronics ignition and safety valve 4 Gasbrenner, elektronische Zündung und Sicherheitsventil | | |

BASSANO ARMADI PENSILI H 43 Prof. 37

BASSANO WALL UNITS H. 43 D. 37

HÄNGESCHRÄNKE BASSANO H. 43 T. 37

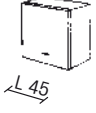

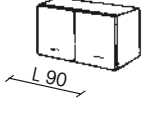

| ATTREZZATURE Equipping Einrichtung | CODICI Code Kode | ELEMENTI Elements Elemente |
|---|------------------------|---|
| Cerniera DX Right hinges Rechte Scharniere | M.240.760 |  |
| Cerniera SX Left hinges Linke Scharniere | M.240.761 | |

| ATTREZZATURE Equipping Einrichtung | CODICI Code Kode | ELEMENTI Elements Elemente |
|--|------------------------|---|
| 2 ante 2 doors 2 Türen | M.240.762 |  |

BASSANO ARMADI PENSILI H 71 Prof. 37

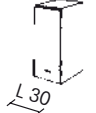
BASSANO WALL UNITS H. 71 D. 37

HÄNGESCHRÄNKE BASSANO H. 71 T. 37

| ATTREZZATURE Equipping Einrichtung | CODICI Code Kode | ELEMENTI Elements Elemente |
|---|------------------------|---|
| Cerniera DX Right hinges Rechte Scharniere | M.240.780 |  |
| Cerniera SX Left hinges Linke Scharniere | M.240.781 | |
| Cerniera DX Right hinges Rechte Scharniere | M.240.784 |  |
| Cerniera SX Left hinges Linke Scharniere | M.240.785 | |
| Cerniera DX Right hinges Rechte Scharniere | M.240.788 |  |
| Cerniera SX Left hinges Linke Scharniere | M.240.789 | |
| Cerniera DX Right hinges Rechte Scharniere | M.240.792 |  |
| Cerniera SX Left hinges Linke Scharniere | M.240.793 | |

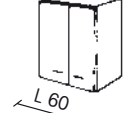
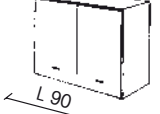
| ATTREZZATURE Equipping Einrichtung | CODICI Code Kode | ELEMENTI Elements Elemente |
|--|------------------------|---|
| 2 ante 2 doors 2 Türen | M.240.794 |  |
| 2 ante 2 doors 2 Türen | M.240.796 |  |